

YASKAWA AC Drive Option Shield Clamp Kit Installation Manual

Model ZHZ-GA50Vx

To properly use the product, read this manual thoroughly and retain for easy reference, inspection, and maintenance. Ensure the end user receives this manual.

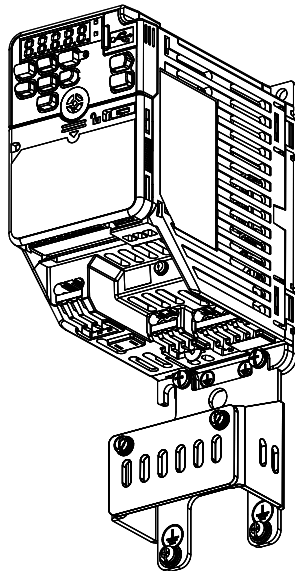

This Page Intentionally Blank

Table of Contents

1.	Receiving	4
	Applicable Documentation	4
	Glossary	4
2.	General Safety	4
	Supplemental Safety Information	4
	Section Safety	4
3.	Overview	5
	Compatible Products	5
	Installation Environment	5
4.	Receiving	6
	Drive Model and Kit	7
	Option Package Contents	7
5.	Exterior and Mounting Dimensions	9
6.	Installation Procedure	13
	Necessary Tools	13
	Kit Models and Installation Procedure	14
	Install the Attachment	14
	External Heatsink	19
	Revision History	20

1 Receiving

◆ Applicable Documentation

Document	Description
YASKAWA AC Drive Option Shield Clamp Kit Installation Manual	Read this manual before you install this option to the drive. This manual gives information about how to safety the wiring for the drive through the shield clamps.
YASKAWA AC Drive Manuals	For information about drive settings, refer to the manuals for the drive with which you will use this option. The manuals provide information about basic installation, wiring, operation procedures, functions, troubleshooting, and maintenance. The manuals also include important information about parameter settings and tuning the drive. You can download drive manuals from the Yaskawa product and technical information website shown on the back cover of this manual.

◆ Glossary

Terminology Used in this Document	Description
Drive	YASKAWA AC Drive GA500
Attachment, Option	Yaskawa Drive Option Shield Clamp Kit

2 General Safety

◆ Supplemental Safety Information

▲ DANGER This signal word identifies a hazard that will cause serious injury or death if you do not prevent it.

▲ WARNING This signal word identifies a hazard that can cause death or serious injuries if you do not prevent it.

▲ CAUTION Identifies a hazardous situation, which, if not avoided, can cause minor or moderate injury.

NOTICE This signal word identifies a property damage message that is not related to personal injury.

◆ Section Safety

General Precautions
<ul style="list-style-type: none"> Some figures in the instructions include options and drives without covers or safety shields to more clearly show the inside of the drive. Replace covers and shields before operation. Use options and drives only as specified by the instructions. The figures in this manual are examples only. All figures do not apply to all products included in this manual. Yaskawa can change the products, specifications, and content of the instructions without notice to make the product and/or the instructions better. If you damage or lose these instructions, contact a Yaskawa representative or the nearest Yaskawa sales office on the rear cover of the manual, and tell them the document number on the front cover to order new copies.

⚠ DANGER *Electrical Shock Hazard. Do not examine, connect, or disconnect wiring on an energized drive. Before servicing, disconnect all power to the equipment and wait for the time specified on the warning label at a minimum. The internal capacitor stays charged after the drive is de-energized. The charge indicator LED extinguishes when the DC bus voltage decreases below 50 Vdc. When all indicators are OFF, measure for dangerous voltages to make sure that the drive is safe. If you do work on the drive when it is energized, it will cause serious injury or death from electrical shock.*

⚠ CAUTION *Burn Hazard. Do not touch a hot drive heatsink. De-energize the drive, wait for a minimum of 15 minutes, then make sure that the heatsink is cool before you replace the cooling fans. If you touch a hot drive heatsink, it can burn you.*

⚠ WARNING *Electrical Shock Hazard. Only let approved personnel install, wire, maintain, examine, replace parts, and repair the drive. If personnel are not approved, it can cause serious injury or death.*

⚠ WARNING *Sudden Movement Hazard. Tighten the screws to the specified tightening torque. Incorrect tightening torques can cause damage to equipment and cause serious injury or death from falling equipment.*

NOTICE *Damage to Equipment. When you touch the drive and circuit boards, make sure that you observe correct electrostatic discharge (ESD) procedures. If you do not follow procedures, it can cause ESD damage to the drive circuitry.*

3 Overview

This option is a shield clamp to safety the wiring for the drive.

Use this option and clamp tools to easily safety the wiring for the drive.

You can use this option when the installation environment of the drive meets the specifications shown in [Installation Environment on page 5](#).

◆ Compatible Products

This installation kit is compatible with these drives:

- GA500

◆ Installation Environment

The installation environment is important for the lifespan of the product and to make sure that the drive performance is correct. Make sure that the installation environment agrees with these specifications.

Environment	Conditions
Area of Use	Indoors
Power Supply	Overvoltage Category III (IEC60664)
Ambient Temperature Setting	IP20/UL Open Type: -10 °C to +50 °C (14 °F to 122 °F) <ul style="list-style-type: none"> • Drive reliability is better in environments where the temperature does not increase or decrease quickly. • When you install the drive in an enclosure, use a cooling fan or air conditioner to keep the internal air temperature in the permitted range. • Do not let the drive freeze.
Humidity	95%RH or less Do not let condensation form on the drive.
Storage Temperature	-20 °C to +70 °C (-4 °F to +158 °F) (short-term temperature during transportation)
Surrounding Area	Pollution degree 2 or less (IEC 60664-1)

Environment	Conditions
	Install the drive in an area without: <ul style="list-style-type: none"> • Oil mist, corrosive or flammable gas, or dust • Metal powder, oil, water, or other unwanted materials • Radioactive or flammable materials. • Harmful gas or fluids • Salt • Direct sunlight Keep wood and other flammable materials away from the drive.
Altitude	1000 m (3281 ft) Maximum Note: Derate the output current by 1% for each 100 m (328 ft) to install the drive in altitudes between 1000 m to 4000 m (3281 ft to 13123 ft). It is not necessary to derate the rated voltage in these conditions: <ul style="list-style-type: none"> • Installing the drive at 2000 m (6562 ft) or lower • Installing the drive between 2000 m to 4000 m (6562 ft to 13123 ft) and grounding the neutral point on the power supply. Contact Yaskawa or your nearest sales representative if you will not ground the neutral point.
Vibration	<ul style="list-style-type: none"> • 10 Hz to 20 Hz: 0.6 G (5.9 m/s², 19.36 ft/s²) • 20 Hz to 55 Hz: 0.2 G (2.0 m/s², 6.56 ft/s²)
Installation Orientation	Install the drive vertically for sufficient airflow to cool the drive.

NOTICE Do not put drive peripheral devices, transformers, or other electronics near the drive. Shield the drive from electrical interference if components must be near the drive. Components near the drive can cause incorrect drive operation from electrical interference.

NOTICE Do not let unwanted objects, for example metal shavings or wire clippings, fall into the drive during drive installation. Put a temporary cover over the drive during installation. Remove the temporary cover before start-up. Unwanted objects inside of the drive can cause damage to the drive.

4 Receiving









1. Examine the products for damage.
 If there is damage to the products, contact the shipping company immediately. The Yaskawa warranty does not include damage from shipping.
2. Verify the product model number to make sure that you received the correct model.
 If you have problems with the products, contact the distributor where you purchased the products or the Yaskawa sales office immediately.

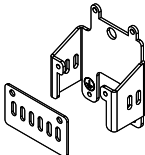

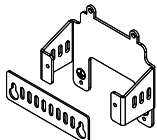

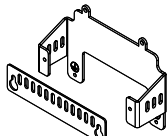

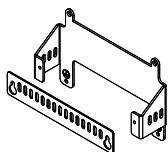

◆ Drive Model and Kit

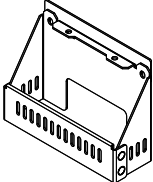
Table 4.1 Drive Model and Kit

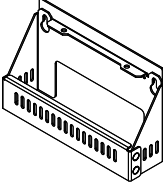
Drive Model			Kit Model ZH-xxxxxx
Single-Phase 200 V Class	Three-Phase 200 V Class	Three-Phase 400 V Class	
B001, B002, B004	2001, 2002, 2004, 2006	-	GA50V1
B006, B010	2008, 2010, 2012	4001, 4002, 4004, 4005, 4007, 4009	GA50V2
B012	2018, 2021	4012	GA50V3
B018	-	-	GA50V4
-	2030, 2042	4018, 4023	GA50V5
	2056	4031, 4038	GA50V6
	2070, 2082	-	GA50V7
	-	4044, 4060	GA50V8

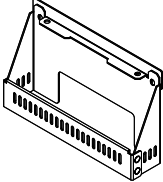
◆ Option Package Contents

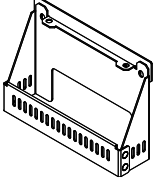
Model ZH-xxxxxx	Kit	Screw and Washer
GA50V1		 M4 pan head screw: #2 M4 ground terminal screw: #2 C-Washer: #2
GA50V2		 M4 pan head screw: #2 M4 ground terminal screw: #2 C-Washer: #2
GA50V3		 M4 pan head screw: #2 M4 ground terminal screw: #2 C-Washer: #2
GA50V4		 M4 pan head screw: #2 M5 ground terminal screw: #2

Model ZH-Z-xxxxxx	Kit	Screw and Washer
GA50V5	 A perspective view of a metal shield clamp kit. It consists of a main rectangular body with a central cutout and a smaller rectangular section on the right side. The bottom edge has a series of small rectangular slots. Two screws are shown at the top corners, securing the top flange.	 M5 pan head screw: #2
GA50V6	 A perspective view of a metal shield clamp kit, similar to GA50V5 but with a different top flange design. It has a central cutout and a smaller rectangular section on the right. The bottom edge has a series of small rectangular slots. Two screws are shown at the top corners.	 M5 pan head screw: #2
GA50V7	 A perspective view of a metal shield clamp kit, similar to GA50V5 but with a different top flange design. It has a central cutout and a smaller rectangular section on the right. The bottom edge has a series of small rectangular slots. Two screws are shown at the top corners.	 M6 pan head screw: #2
GA50V8	 A perspective view of a metal shield clamp kit, similar to GA50V5 but with a different top flange design. It has a central cutout and a smaller rectangular section on the right. The bottom edge has a series of small rectangular slots. Two screws are shown at the top corners.	 M6 pan head screw: #2

5 Exterior and Mounting Dimensions

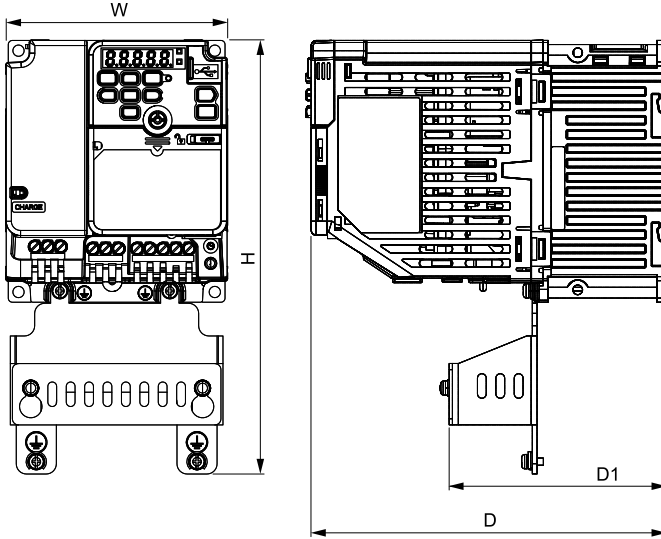

Figure 5.1 Exterior and Mounting Dimensions

Table 5.1 Single-Phase 200 V Class (without Built-in EMC Filter)

Drive Model	Dimensions mm (in)				Est. Weight kg (lb)
	W	H	D	D1	
B001	68 (2.67)	205 (8.07)	76 (2.99)	46 (1.81)	0.65 (1.43)
B002	68 (2.67)	205 (8.07)	76 (2.99)	46 (1.81)	0.65 (1.43)
B004	68 (2.67)	205 (8.07)	118 (4.64)	78 (3.07)	0.95 (2.09)
B006	108 (4.25)	212 (8.34)	137.5 (5.41)	106.5 (4.19)	1.7 (3.74)
B010	108 (4.25)	212 (8.34)	137.5 (5.41)	106.5 (4.19)	1.7 (3.74)
B012	140 (5.51)	212 (8.34)	163 (6.41)	114.3 (4.5)	2.35 (5.18)
B018	170 (6.69)	222 (8.74)	180 (7.08)	115.3 (4.53)	3.22 (7.09)

Table 5.2 Single-Phase 200 V Class (with Built-in EMC Filter)

Drive Model	Dimensions mm (in)				Est. Weight kg (lb)
	W	H	D	D1	
B001	68 (2.67)	205 (8.07)	116 (4.56)	46 (1.81)	0.85 (1.87)
B002	68 (2.67)	205 (8.07)	116 (4.56)	46 (1.81)	0.85 (1.87)
B004	68 (2.67)	205 (8.07)	158 (6.22)	78 (3.07)	1.15 (2.53)
B006	108 (4.25)	212 (8.34)	182.5 (7.18)	106.5 (4.19)	2 (4.4)
B010	108 (4.25)	212 (8.34)	199 (7.83)	106.5 (4.19)	2 (4.4)
B012	140 (5.51)	212 (8.34)	203 (7.99)	114.3 (4.5)	2.95 (6.5)

Table 5.3 Three-Phase 200 V Class (without Built-in EMC Filter)

Drive Model	Dimensions mm (in)				Est. Weight kg (lb)
	W	H	D	D1	
2001	68 (2.67)	205 (8.07)	76 (2.99)	54.5 (2.14)	0.65 (1.43)
2002	68 (2.67)	205 (8.07)	76 (2.99)	54.5 (2.14)	0.65 (1.43)
2004	68 (2.67)	205 (8.07)	108 (4.25)	78 (3.07)	0.95 (2.09)
2006	68 (2.67)	205 (8.07)	128 (5.03)	98 (3.85)	1.05 (2.31)
2008	108 (4.25)	212 (8.34)	129 (5.07)	106.5 (4.19)	1.7 (3.74)
2010	108 (4.25)	212 (8.34)	129 (5.07)	106.5 (4.19)	1.7 (3.74)
2012	108 (4.25)	212 (8.34)	137.5 (5.41)	106.5 (4.19)	1.7 (3.74)
2018	140 (5.51)	212 (8.34)	143 (5.62)	114.3 (4.5)	2.25 (4.96)
2021	140 (5.51)	212 (8.34)	143 (5.62)	114.3 (4.5)	2.25 (4.96)
2030	140 (5.51)	360 (14.17)	140 (5.51)	108 (4.25)	3.71 (8.17)
2042	140 (5.51)	360 (14.17)	140 (5.51)	108 (4.25)	3.91 (8.62)

Drive Model	Dimensions mm (in)				Est. Weight kg (lb)
	W	H	D	D1	
2056	180 (7.08)	400 (15.74)	143 (5.62)	108 (4.25)	5.84 (12.87)
2070	220 (8.66)	470 (18.5)	187 (7.36)	131 (5.15)	7.97 (17.57)
2082	220 (8.66)	470 (18.5)	187 (7.36)	131 (5.15)	8.47 (18.67)

Table 5.4 Three-Phase 200 V Class (with Built-in EMC Filter)

Drive Model	Dimensions mm (in)				Est. Weight kg (lb)
	W	H	D	D1	
2001	68 (2.67)	205 (8.07)	116 (4.56)	54.5 (2.14)	0.75 (1.65)
2002	68 (2.67)	205 (8.07)	116 (4.56)	54.5 (2.14)	0.75 (1.65)
2004	68 (2.67)	205 (8.07)	148 (5.82)	78 (3.07)	1.05 (2.31)
2006	68 (2.67)	205 (8.07)	168 (6.61)	98 (3.85)	1.25 (2.75)
2008	108 (4.25)	212 (8.34)	174 (6.85)	106.5 (4.19)	1.8 (3.96)
2010	108 (4.25)	212 (8.34)	174 (6.85)	106.5 (4.19)	1.8 (3.96)
2012	108 (4.25)	212 (8.34)	182.5 (7.18)	106.5 (4.19)	1.8 (3.96)
2018	140 (5.51)	212 (8.34)	193 (7.59)	114.3 (4.5)	2.65 (5.84)
2021	140 (5.51)	212 (8.34)	193 (7.59)	114.3 (4.5)	2.65 (5.84)
2030	140 (5.51)	360 (14.17)	196 (7.71)	108 (4.25)	4.21 (9.28)
2042	140 (5.51)	360 (14.17)	196 (7.71)	108 (4.25)	4.41 (9.72)
2056	180 (7.08)	400 (15.74)	196 (7.71)	108 (4.25)	6.34 (13.97)
2070	220 (8.66)	470 (18.5)	216 (8.5)	131 (5.15)	8.97 (19.77)
2082	220 (8.66)	470 (18.5)	216 (8.5)	131 (5.15)	9.47 (20.87)

Table 5.5 Three-Phase 400 V Class (without Built-in EMC Filter)

Drive Model	Dimensions mm (in)				Est. Weight kg (lb)
	W	H	D	D1	
4001	108 (4.25)	212 (8.34)	81 (3.18)	58.5 (2.3)	1 (2.2)
4002	108 (4.25)	212 (8.34)	99 (3.89)	85 (3.34)	1.1 (2.42)
4004	108 (4.25)	212 (8.34)	137.5 (5.41)	106.5 (4.19)	1.7 (3.74)
4005	108 (4.25)	212 (8.34)	154 (6.06)	106.5 (4.19)	1.7 (3.74)
4007	108 (4.25)	212 (8.34)	154 (6.06)	106.5 (4.19)	1.7 (3.74)
4009	108 (4.25)	212 (8.34)	154 (6.06)	106.5 (4.19)	1.7 (3.74)
4012	140 (5.51)	212 (8.34)	143 (5.62)	114.3 (4.5)	2.25 (4.96)
4018	140 (5.51)	360 (14.17)	140 (5.51)	108 (4.25)	3.31 (7.29)
4023	140 (5.51)	360 (14.17)	140 (5.51)	108 (4.25)	3.51 (7.73)
4031	180 (7.08)	400 (15.74)	143 (5.62)	108 (4.25)	4.94 (10.89)
4038	180 (7.08)	400 (15.74)	143 (5.62)	108 (4.25)	5.14 (11.33)
4044	190 (7.48)	470 (18.5)	204 (8.03)	147 (5.78)	6.91 (15.23)
4060	190 (7.48)	470 (18.5)	204 (8.03)	147 (5.78)	6.91 (15.23)

Table 5.6 Three-Phase 400 V Class (with Built-in EMC Filter)

Drive Model	Dimensions mm (in)				Est. Weight kg (lb)
	W	H	D	D1	
4001	108 (4.25)	212 (8.34)	126 (4.96)	58.5 (2.3)	1.6 (3.52)
4002	108 (4.25)	212 (8.34)	144 (5.66)	85 (3.34)	1.7 (3.74)
4004	108 (4.25)	212 (8.34)	182.5 (7.18)	106.5 (4.19)	2.1 (4.62)
4005	108 (4.25)	212 (8.34)	199 (7.83)	106.5 (4.19)	2.1 (4.62)

Drive Model	Dimensions mm (in)				Est. Weight kg (lb)
	W	H	D	D1	
4007	108 (4.25)	212 (8.34)	199 (7.83)	106.5 (4.19)	2.1 (4.62)
4009	108 (4.25)	212 (8.34)	199 (7.83)	106.5 (4.19)	2.1 (4.62)
4012	140 (5.51)	212 (8.34)	193 (7.59)	114.3 (4.5)	2.85 (6.28)
4018	140 (5.51)	360 (14.17)	196 (7.71)	108 (4.25)	4.21 (9.28)
4023	140 (5.51)	360 (14.17)	196 (7.71)	108 (4.25)	4.21 (9.28)
4031	180 (7.08)	400 (15.74)	196 (7.71)	108 (4.25)	5.84 (12.87)
4038	180 (7.08)	400 (15.74)	196 (7.71)	108 (4.25)	5.84 (12.87)
4044	190 (7.48)	470 (18.5)	251 (9.88)	147 (5.78)	8.41 (18.54)
4060	190 (7.48)	470 (18.5)	251 (9.88)	147 (5.78)	8.91 (19.64)

6 Installation Procedure

◆ Necessary Tools

To install the kit, use these tools:

- Phillips screwdriver #1
- Phillips screwdriver #2
- Cable tie
- Cable clamp

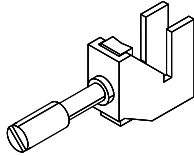
Drive Model	Cable Clamp Model Product of icotek	
B001 - B004 2001 - 2006	SKS 3-14	
B006 - B018 2008 - 2042 4001 - 4038	SKS 3-20	
2056 - 2082 4044, 4060	SKS 20-35	

◆ Kit Models and Installation Procedure

▲ CAUTION *Crush Hazard. Tighten terminal cover screws and hold the case safely when you move the drive. If the drive or covers fall, it can cause moderate injury.*

The installation procedure is different for different drive models. Refer to [Table 6.1](#).

Table 6.1 Kit and Installation Method

Drive Model			Kit Model ZH-Z-xxxxxx	Installation Procedure	Reference
Single-Phase 200 V Class	Three-Phase 200 V Class	Three-Phase 400 V Class			
B001, B002, B004	2001, 2002, 2004, 2006	-	GA50V1	Procedure A	14
B006, B010	2008, 2010, 2012	4001, 4002, 4004, 4005, 4007, 4009	GA50V2		
B012	2018, 2021	4012	GA50V3		
B018	-	-	GA50V4		
-	2030, 2042	4018, 4023	GA50V5	Procedure B	17
	2056	4031, 4038	GA50V6		
	2070, 2082	-	GA50V7		
	-	4044, 4060	GA50V8		

■ Install the Attachment

Use the External Heatsink Installation Kit (Procedure A)

1. Remove the drive ground terminal screws.

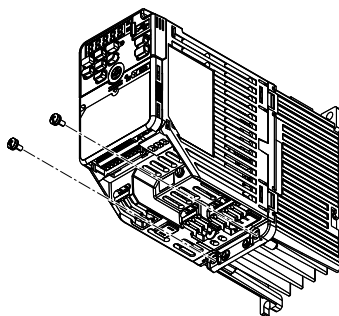
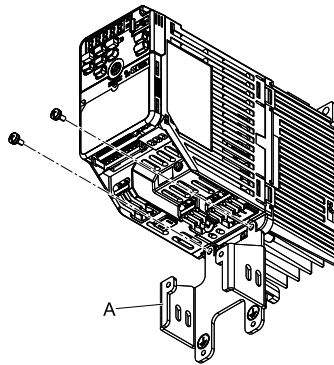

Figure 6.1 Remove the Ground Terminal Screws

2. Use the ground terminal screws to install the shield clamp base on the drive. Tighten the screws to a correct tightening torque:
 - M3.5 × 7 pan head screws: 0.69 N·m to 0.98 N·m (6.11 in·lb to 8.67 in·lb)
 - M4 × 8 pan head screws: 0.98 N·m to 1.33 N·m (8.67 in·lb to 11.77 in·lb)
 - M5 × 10 pan head screws: 1.96 N·m to 2.53 N·m (17.35 in·lb to 22.39 in·lb)



A - Shield Clamp Base

Figure 6.2 Install the Shield Clamp Base

3. Wire the input/output terminals.

Use the supplied ground terminal screws and C-Washer to wire the grounding wire to the ground terminal holes on the shield clamp base.

Note:

If you select a 4-core wire as the grounding wire as specified by the applicable wire size of the input terminal, the grounding wire can be larger than the applicable wire size shown in the drive installation manual. If this occurs, you can connect the grounding wires to the ground terminals of the shield clamp base.

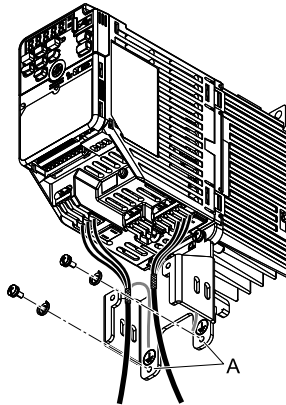

A - Ground terminal holes

Figure 6.3 Wire the Input/Output Terminals

4. Install the front cover.

Tighten the screws to a correct tightening torque:

- M4 pan head screws: 0.98 N·m to 1.33 N·m (8.67 in·lb to 11.77 in·lb)

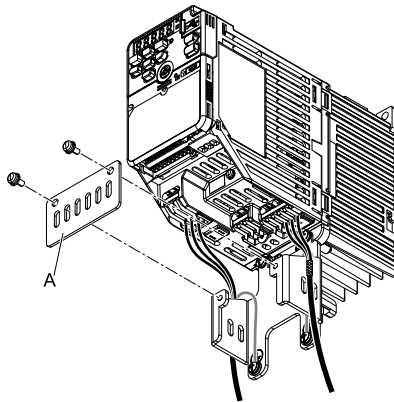

A - Front cover

Figure 6.4 Install the Front Cover

Note:

The front cover mounting holes on models GA50V2 to GA50V4 are the bell-shaped holes. Loosen the screws to install or remove the front cover.

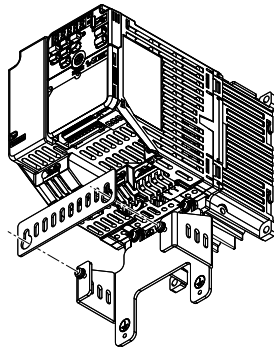

5. Use cable ties or cable clamps to safety the cables to the front cover.

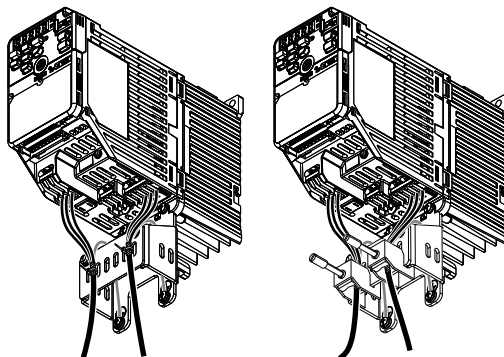
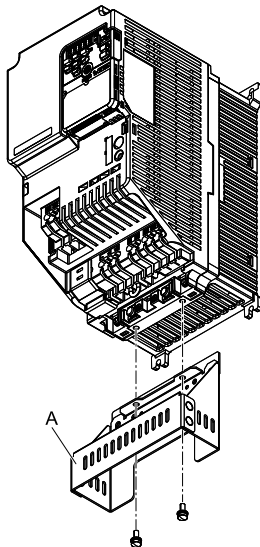

Figure 6.5 Safety the Cables

Install the Attachment (Procedure B)

1. Use the supplied screws to install the kit to the drive.
Tighten the screws to a correct tightening torque:
 - M5 × 10 pan head screws: 1.96 N·m to 2.53 N·m (17.35 in·lb to 22.39 in·lb)
 - M6 × 12 pan head screws: 3.92 N·m to 4.9 N·m (34.70 in·lb to 43.37 in·lb)



A - Kit

Figure 6.6 Install the Attachment

2. Wire the input/output terminals.
Connect the grounding wire to the ground terminal of the drive.

Note:

- If you select a 4-core wire as the grounding wire as specified by the applicable wire size of the input terminal, the grounding wire can be larger than the applicable wire size shown in the drive installation manual. If this occurs, you can connect the grounding wires to the ground terminals of the drive.
- Use these closed-loop crimp terminals or equivalent to connect a protective ground wire.
 - NS series or S series from JST Mfg. Co., Ltd.
 - S series from NICHIFU Co., Ltd.
 - LCA series or P series from PANDUIT Corp.

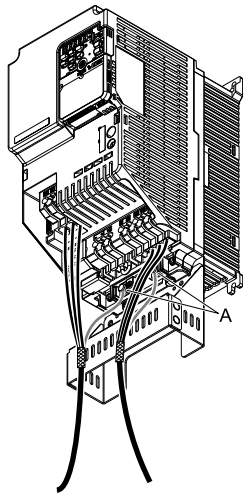

A - Ground terminal

Figure 6.7 Wire the Input/Output Terminals

3. Use cable ties or cable clamps to safety the cables to the kit.

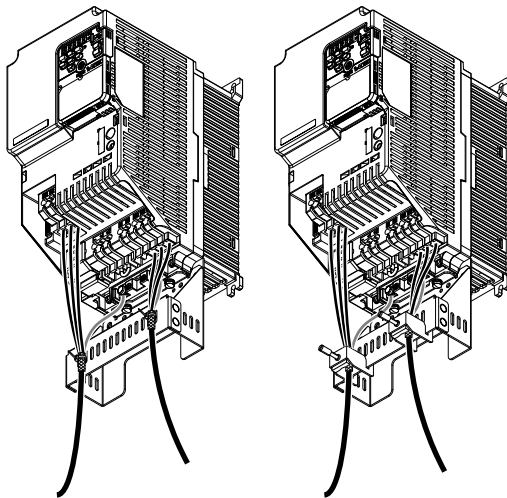

Figure 6.8 Safety the Cables

External Heatsink

When you use this kit and the heatsink external mounting kit to install one of these drive models, install this kit as an alternative to bracket 2 for the bottom of the drive.

Refer to “Heatsink External Mounting Kit Installation Manual (TOEP C720600 09)” for more information about how to install the heatsink external mounting kit.

Drive Model			Shield Clamp Kit Model ZHZ-xxxxxx	Heatsink External Mounting Kit Model ZPSA-xxxxxx-x
Single-Phase 200 V Class	Three-Phase 200 V Class	Three-Phase 400 V Class		
	2030, 2042	4018, 4023	GA50V5	GA50V5-1
	2056	4031, 4038	GA50V6	GA50V6-1
	2070, 2082	-	GA50V7	GA50V7-1
	-	4044, 4060	GA50V8	GA50V8-1

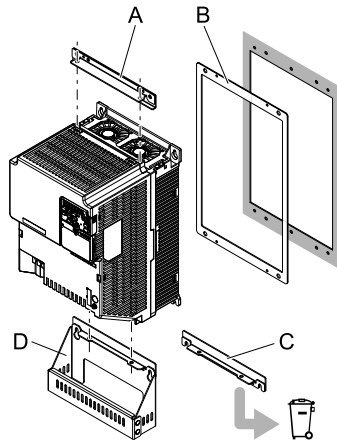

A - Bracket 1
B - Frame

C - Bracket 2
D - Shield Clamp Kit

Revision History

Date of Publication	Revision Number	Section	Revised Content
September 2020	-	-	First Edition



YASKAWA AC Drive Option Shield Clamp Kit Installation Manual

DRIVE CENTER (INVERTER PLANT)

2-13-1, Nishimiyaichi, Yukuhashi, Fukuoka,
824-8511, Japan
Phone: +81-930-25-2548 Fax: +81-930-25-3431
www.yaskawa.co.jp

YASKAWA ELECTRIC CORPORATION

New Pier Takeshiba South Tower, 1-16-1, Kaigan,
Minatoku, Tokyo, 105-6891, Japan
Phone: +81-3-5402-4502 Fax: +81-3-5402-4580
www.yaskawa.co.jp

YASKAWA AMERICA, INC.

2121, Norman Drive South, Waukegan, IL 60085, U.S.A.
Phone: +1-800-YASKAWA (927-5292) or +1-847-887-7000
Fax: +1-847-887-7310
www.yaskawa.com

YASKAWA ELÉTRICO DO BRASIL LTDA.

777, Avenida Piraporinha, Diadema, São Paulo,
09950-000, Brasil
Phone: +55-11-3585-1100 Fax: +55-11-3585-1187
www.yaskawa.com.br

YASKAWA EUROPE GmbH

Hauptstraße 185, 65760 Eschborn, Germany
Phone: +49-6196-569-300 Fax: +49-6196-569-398
www.yaskawa.eu.com
E-mail: info@yaskawa.eu.com

YASKAWA ELECTRIC KOREA CORPORATION

35F, Three IFC, 10 Gukjegeumyung-ro,
Yeongdeungpo-gu, Seoul, 07326, Korea
Phone: +82-2-784-7844 Fax: +82-2-784-8495
www.yaskawa.co.kr

YASKAWA ASIA PACIFIC PTE. LTD.

30A, Kallang Place, #06-01, 339213, Singapore
Phone: +65-6282-3003 Fax: +65-6289-3003
www.yaskawa.com.sg

YASKAWA ELECTRIC (THAILAND) CO., LTD.

59, 1F-5F, Flourish Building, Soi Ratchadapisek 18,
Ratchadapisek Road, Huaykwang, Bangkok, 10310,
Thailand
Phone: +66-2-017-0099 Fax: +66-2-017-0799
www.yaskawa.co.th

YASKAWA ELECTRIC (CHINA) CO., LTD.

22F, Link Square 1, No.222, Hubin Road, Shanghai,
200021, China
Phone: +86-21-5385-2200 Fax: +86-21-5385-3299
www.yaskawa.com.cn

YASKAWA ELECTRIC (CHINA) CO., LTD. BEIJING OFFICE

Room 1011, Tower W3 Oriental Plaza, No. 1,
East Chang An Avenue,
Dong Cheng District, Beijing, 100738, China
Phone: +86-10-8518-4086 Fax: +86-10-8518-4082

YASKAWA ELECTRIC TAIWAN CORPORATION

12F, No. 207, Section 3, Beishin Road, Shindian District,
New Taipei City 23143, Taiwan
Phone: +886-2-8913-1333
Fax: +886-2-8913-1513 or +886-2-8913-1519
www.yaskawa.com.tw

YASKAWA INDIA PRIVATE LIMITED

#17/A, Electronics City, Hosur Road, Bengaluru,
560 100 (Karnataka), India
Phone: +91-80-4244-1900 Fax: +91-80-4244-1901
www.yaskawaindia.in

YASKAWA

YASKAWA ELECTRIC CORPORATION

In the event that the end user of this product is to be the military and said product is to be employed in any weapons systems or the manufacture thereof, the export will fall under the relevant regulations as stipulated in the Foreign Exchange and Foreign Trade Regulations. Therefore, be sure to follow all procedures and submit all relevant documentation according to any and all rules, regulations and laws that may apply.

Specifications are subject to change without notice for ongoing product modifications and improvements.

© 2020 YASKAWA Electric Corporation



TOEPC72060015

MANUAL NO. TOEP C720600 15A <0>->
Published in Japan September 2020
20-2-22