



YASKAWA

YASKAWA AC Drive-V1000 Option

# PROFIBUS-DP Installation Manual

Type SI-P3/V

To properly use the product, read this manual thoroughly and retain for easy reference, inspection, and maintenance. Ensure the end user receives this manual.

## V1000オプションユニット PROFIBUS-DP通信 取扱説明書

形式 SI-P3/V

製品を安全にお使い頂くために、この取扱説明書を必ずお読みください。  
また、本書をお手元に保管していただくとともに、最終的に本製品をご使用になるユーザー様のお手元に確実に届けられるよう、お取り計らい願います。

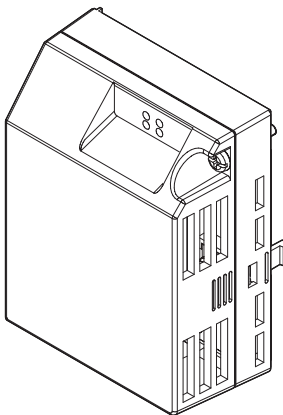



# Table of Contents

---

<b>1 PREFACE AND SAFETY .....</b>	<b>3</b>
<b>2 PRODUCT OVERVIEW .....</b>	<b>8</b>
<b>3 RECEIVING .....</b>	<b>9</b>
<b>4 PROFIBUS-DP OPTION COMPONENTS .....</b>	<b>10</b>
<b>5 INSTALLATION PROCEDURE .....</b>	<b>14</b>
<b>6 PROFIBUS-DP OPTION DRIVE PARAMETERS .....</b>	<b>22</b>
<b>7 PROFIBUS-DP OPTION DATA AND I/O MAPS .....</b>	<b>23</b>
<b>8 TROUBLESHOOTING .....</b>	<b>27</b>
<b>9 SPECIFICATIONS .....</b>	<b>30</b>

---

Copyright © 2007 YASKAWA ELECTRIC CORPORATION

All rights reserved. No part of this publication may be reproduced, stored in a retrieval system, or transmitted, in any form or by any means, mechanical, electronic, photocopying, recording, or otherwise, without the prior written permission of Yaskawa. No patent liability is assumed with respect to the use of the information contained herein. Moreover, because Yaskawa is constantly striving to improve its high-quality products, the information contained in this manual is subject to change without notice. Every precaution has been taken in the preparation of this manual. Yaskawa assumes no responsibility for errors or omissions. Neither is any liability assumed for damages resulting from the use of the information contained in this publication.

# 1 Preface and Safety

Yaskawa manufactures products used as components in a wide variety of industrial systems and equipment. The selection and application of Yaskawa products remain the responsibility of the equipment manufacturer or end user. Yaskawa accepts no responsibility for the way its products are incorporated into the final system design. Under no circumstances should any Yaskawa product be incorporated into any product or design as the exclusive or sole safety control. Without exception, all controls should be designed to detect faults dynamically and fail safely under all circumstances. All systems or equipment designed to incorporate a product manufactured by Yaskawa must be supplied to the end user with appropriate warnings and instructions as to the safe use and operation of that part. Any warnings provided by Yaskawa must be promptly provided to the end user. Yaskawa offers an express warranty only as to the quality of its products in conforming to standards and specifications published in the Yaskawa manual. **NO OTHER WARRANTY, EXPRESS OR IMPLIED, IS OFFERED.** Yaskawa assumes no liability for any personal injury, property damage, losses, or claims arising from misapplication of its products.

# 1 Preface and Safety

---

## ◆ Applicable Documentation

The following manuals are available for the PROFIBUS-DP Option:

### Option Unit

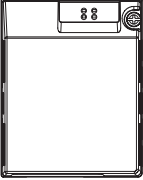
	<b>Yaskawa AC Drive -V1000 Option PROFIBUS-DP Installation Manual</b>
	Read this manual first. The installation manual is packaged with the PROFIBUS-DP Option and contains a basic overview of wiring, settings, functions, and fault diagnoses.
	<b>Yaskawa AC Drive -V1000 Option PROFIBUS-DP Technical Manual</b>
	The technical manual contains detailed information and command registers. To obtain the technical manual access these sites: U.S.: <a href="http://www.yaskawa.com">http://www.yaskawa.com</a> Europe: <a href="http://www.yaskawa.eu.com">http://www.yaskawa.eu.com</a> Japan: <a href="https://www.e-mechatronics.com">https://www.e-mechatronics.com</a> Other areas: contact a Yaskawa representative.

### Yaskawa Drive

	<b>Yaskawa AC Drive-V1000 Installation &amp; Start-Up Manual</b>	To obtain instruction manuals for Yaskawa products access these sites: U.S.: <a href="http://www.yaskawa.com">http://www.yaskawa.com</a> Europe: <a href="http://www.yaskawa.eu.com">http://www.yaskawa.eu.com</a> Japan: <a href="https://www.e-mechatronics.com">https://www.e-mechatronics.com</a> Other areas: contact a Yaskawa representative.
	<b>Yaskawa AC Drive-V1000 Technical Manual</b>	
	<b>Yaskawa AC Drive-V1000 Quick Start Guide</b>	

## ◆ Terms

**Note:** Indicates a supplement or precaution that does not cause drive damage.

**Drive:** Yaskawa AC Drive -V1000 Series

**PROFIBUS Option:** Yaskawa AC Drive -V1000 Option PROFIBUS-DP

## ◆ Registered Trademarks

- PROFIBUS-DP is a registered trademark of PROFIBUS International.
- Other company names and product names listed in this manual are registered trademarks of those companies.

## ◆ Supplemental Safety Information

Read and understand this manual before installing, operating, or servicing this option unit. The option unit must be installed according to this manual and local codes.

The following conventions are used to indicate safety messages in this manual. Failure to heed these messages could result in serious or possibly even fatal injury or damage to the products or to related equipment and systems.

### **DANGER**

Indicates a hazardous situation, which, if not avoided, will result in death or serious injury.

### **WARNING**

Indicates a hazardous situation, which, if not avoided, could result in death or serious injury.

### **CAUTION**

Indicates a hazardous situation, which, if not avoided, could result in minor or moderate injury.

### **NOTICE**

Indicates an equipment damage message.

# 1 Preface and Safety

---

## ■ General Safety

### General Precautions

- The diagrams in this section may include option units and drives without covers or safety shields to illustrate details. Be sure to reinstall covers or shields before operating any devices. The option board should be used according to the instructions described in this manual.
- Any illustrations, photographs, or examples used in this manual are provided as examples only and may not apply to all products to which this manual is applicable.
- The products and specifications described in this manual or the content and presentation of the manual may be changed without notice to improve the product and/or the manual.
- When ordering a new copy of the manual due to damage or loss, contact your Yaskawa representative or the nearest Yaskawa sales office and provide the manual number shown on the front cover.

### DANGER

#### **Heed the safety messages in this manual.**

Failure to comply will result in death or serious injury.

The operating company is responsible for any injuries or equipment damage resulting from failure to heed the warnings in this manual.

### NOTICE

#### **Do not expose the drive to halogen group disinfectants.**

Failure to comply may cause damage to the electrical components in the option unit.

Do not pack the drive in wooden materials that have been fumigated or sterilized.

Do not sterilize the entire package after the product is packed.

## ■ Option Unit Label Warnings

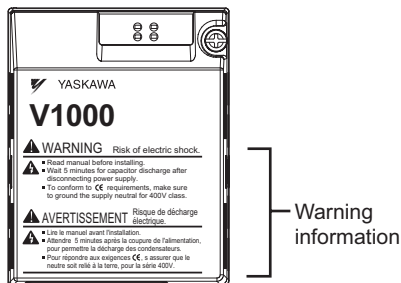

Warning information is displayed on the option unit as shown in the figure below. Follow all warnings and safety instructions when using the product.

When using the drive in an area that may require displaying warning information in Japanese or Chinese, a sticker is provided with the PROFIBUS Option. This sticker can be placed over the English and French warnings on the front of the PROFIBUS Option.





## ■ Warning Contents

### **WARNING** Risk of electric shock.

-  ■ Read manual before installing.
-  ■ Wait 5 minutes for capacitor discharge after disconnecting power supply.
-  ■ To conform to **CE** requirements, make sure to ground the supply neutral for 400V class.

### **AVERTISSEMENT** Risque de décharge électrique.

-  ■ Lire le manuel avant l'installation.
-  ■ Attendre 5 minutes après la coupure de l'alimentation, pour permettre la décharge des condensateurs.
-  ■ Pour répondre aux exigences **CE**, s'assurer que le neutre soit relié à la terre, pour la série 400V.



# 2 Product Overview

### ◆ About This Product

PROFIBUS is an open digital communication system supporting a wide range of fast, time-critical applications.

PROFIBUS-DP (Decentral Periphery) is one of the three PROFIBUS variants. DP is dedicated to fast data communication between systems and peripherals at a field level. This PROFIBUS-DP Option connects a drive to a field network using the PROFIBUS-DP protocol.

PROFIBUS-DP is included into the European Fieldbus Standard EN 50170.

The network is primarily used in process and factory automation.

By installing the PROFIBUS-DP Option to a drive, it is possible to do the followings from a PROFIBUS-DP master device:

- operate the drive
- monitor the operation status of the drive
- change parameter settings

### ◆ Applicable Models

The PROFIBUS-DP Option can be used with the drive models in [Table 1](#).

**Table 1 Applicable Models**

Drive	Software Version*
CIMR-V□□A□□□□AA□	1010 or later
CIMR-V□□A□□□□BA□	1010 or later
CIMR-V□□A□□□□FA□	1010 or later

\*See “PRG” on the drive nameplate for the software version number.

## 3 Receiving

Please perform the following tasks after receiving the PROFIBUS-DP Option:

- Inspect the PROFIBUS-DP Option for damage.  
If the PROFIBUS-DP Option appears damaged upon receipt, contact the shipper immediately.
- Verify receipt of the correct model by checking the information on the PCB (see Figure 1).
- If you have received the wrong model or the PROFIBUS-DP Option does not function properly, contact your supplier.

### ◆ Contents and Packaging

Table 2 Contents of Package

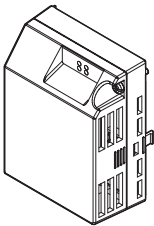
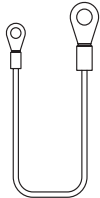
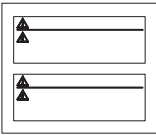
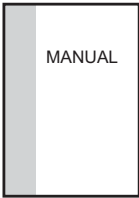
Description:	Option Front Cover	Ground Cables	Warning Labels	Installation Manual
—				
<b>Quantity:</b>	1	4	1	1

### ◆ Tool Requirements

A Phillips screwdriver (M3, M3.5 to M6\*) metric or (#1, #2\*) U.S. standard size is required to install the PROFIBUS-DP Option.

\*Screw sizes vary by drive capacity. Select a screwdriver that matches the drive capacity.

**Note:** Tools required to prepare PROFIBUS cables for wiring are not listed in this manual.

# 4 PROFIBUS-DP Option Components

### ◆ PROFIBUS-DP Option

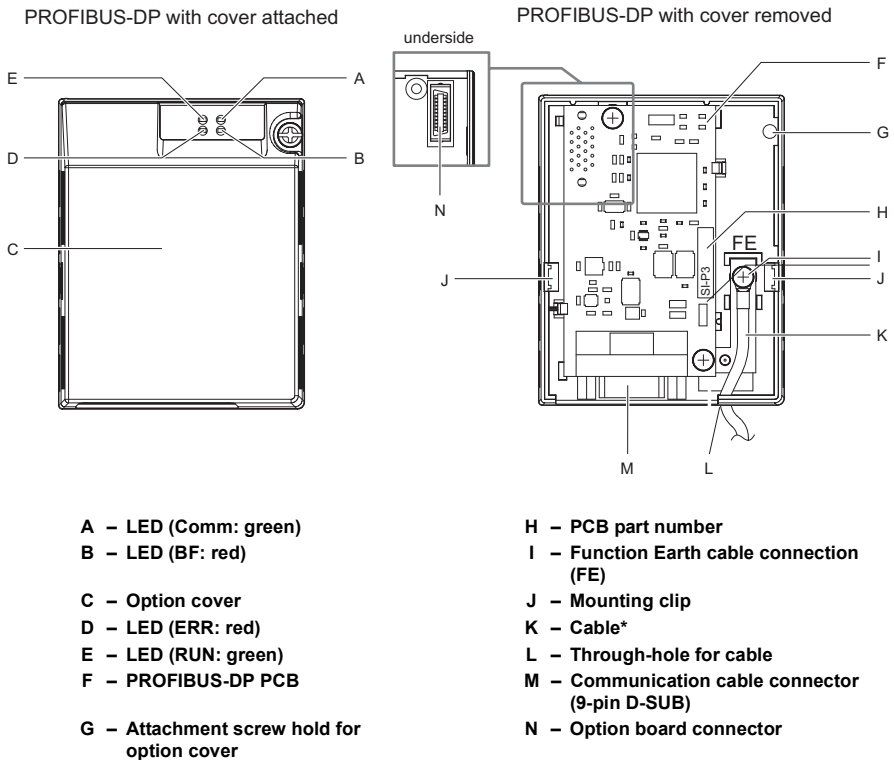

Figure 1 Option Unit

\*Cables are not connected to the PROFIBUS-DP Option and are packaged separately in the box.

**Note:** For details on the LEDs, see [Refer to PROFIBUS-DP Option LED Display on page 13.](#)

### ◆ Dimensions

The installed PROFIBUS-DP Option adds 27 mm (1.06 in.) to the total depth of the drive.

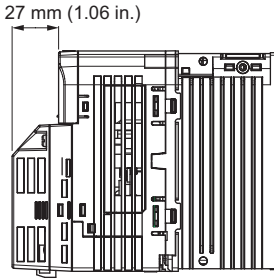

Figure 2 Dimensions

### ◆ Communication connector

The communication connector is a 9-pin D-SUB board-mounted connection. This connector is the connection point of the PROFIBUS network communication cable to the SI-P3/V PROFIBUS-DP Option.

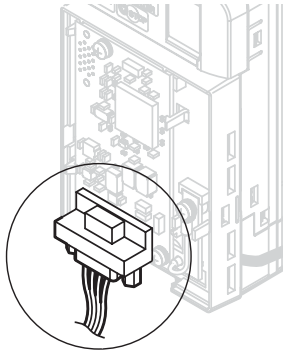
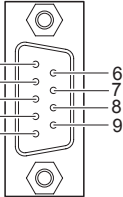

Figure 3 Communication connector location

## 4 PROFIBUS-DP Option Components

**Table 3 Communication connector (9-pin D-SUB)**

PROFIBUS Connector	Pin	Signal	Description
<p>Bottom View</p> 	1	Shield	Connected to the metal-shell (no direct FG-connection)
	2	–	–
	3	RxD/TxD-P	Receive/Transmit data; line B (red)
	4	CNTR-P	Control signal for repeaters (direction control)
	5	DGND	Data ground (reference voltage to VP)
	6	VP	Power supply output for bus termination (+5V, greater than or equal to 10 mA)
	7	–	–
	8	RxD/TxD-N	Receive/Transmit data; line A (green)
	9	–	–

### ◆ PROFIBUS-DP Option LED Display

**Table 4 LED Display**

LED	Display		Communication Status	Meaning
	Color	Status		
RUN (Power)	Green	ON	Power is on	Power is being properly supplied to SI-P3/V, and SI-P3/V has completed its hardware self-diagnostics check
		OFF	Power is off	<ul style="list-style-type: none"> <li>• The drive has no power supply</li> <li>• SI-P3/V and drive are not connected properly and/or there is no power supplied to the SI-P3/V</li> </ul>
ERR (Option Error)	Red	ON	SI-P3/V error	Self-diagnostics error occurred in the SI-P3/V
		Flashing	Drive connection error	Connection error between SI-P3/V and drive. This includes node address setting errors to parameter F6-30 on the drive side
		OFF	No error is present	Either there is no error or the power supply is off. Assuming the power is supplied, this LED will remain off provided that there are no problems with the communication settings for the PROFIBUS-DP Option
COMM (Communication Status)	Green	ON	Communication connected	Normal send/receive between SI-P3/V and PROFIBUS-DP master
		OFF	No data exchange	There is a problem and communication cannot be established between SI-P3/V and the PROFIBUS-DP master
BF (PROFIBUS-DP Error)	Red	ON	Waiting for comm. procedure setting	PROFIBUS-DP master is initializing parameters or is online
		Flashing	Communication setting error	Communication parameter error from PROFIBUS-DP master
		OFF	No error is present	Either there is no error or the power supply is off. Assuming the power is supplied, this LED will remain off provided that there are no problems with the communication settings from the PROFIBUS-DP master

### ◆ Setting Node Address

Set drive parameter F6-30 to a node address (Range 0 to 125) unique to the network.

# 5 Installation Procedure

### ◆ Section Safety

#### DANGER

##### **Electrical Shock Hazard**

**Do not connect or disconnect wiring while the power is on.**

Failure to comply will result in death or serious injury.

Disconnect all power to the drive, wait at least five minutes after all indicators are off, measure the DC bus voltage to confirm safe level, and check for unsafe voltages before servicing to prevent electric shock. The internal capacitor remains charged even after the power supply is turned off. The charge indicator LED will extinguish when the DC bus voltage is below 50 Vdc.

#### WARNING

##### **Electrical Shock Hazard**

**Do not remove option board cover while the power is on.**

Failure to comply could result in death or serious injury.

The diagrams in this section may include option units and drives without covers or safety shields to show details. Be sure to reinstall covers or shields before operating any devices. The option board should be used according to the instructions described in this manual.

**Do not allow unqualified personnel to use equipment.**

Failure to comply could result in death or serious injury.

Maintenance, inspection, and replacement of parts must be performed only by authorized personnel familiar with installation, adjustment, and maintenance of this product.

### **WARNING**

**Do not use damaged wires, place excessive stress on wiring, or damage the wire insulation.**

Failure to comply could result in death or serious injury.

#### **Fire Hazard**

**Tighten all terminal screws to the specified tightening torque.**

Loose electrical connections could result in death or serious injury by fire due to overheating of electrical connections.

### **NOTICE**

#### **Damage to Equipment**

**Observe proper electrostatic discharge procedures (ESD) when handling the option unit, drive, and circuit boards.**

Failure to comply may result in ESD damage to circuitry.

**Never shut the power off while the drive is outputting voltage.**

Failure to comply may cause the application to operate incorrectly or damage the drive.

**Do not operate damaged equipment.**

Failure to comply may cause further damage to the equipment.

Do not connect or operate any equipment with visible damage or missing parts.

**Do not use unshielded cable for control wiring.**

Failure to comply may cause electrical interference resulting in poor system performance.

Use shielded twisted-pair wires and ground the shield to the ground terminal of the drive.



## 5 Installation Procedure

### NOTICE

**Properly connect all pins and connectors.**

Failure to comply may prevent proper operation and possibly damage equipment.

**Check wiring to ensure that all connections are correct after installing the option unit and connecting any other devices.**

Failure to comply may result in damage to the option unit.

### ◆ Wiring Diagram

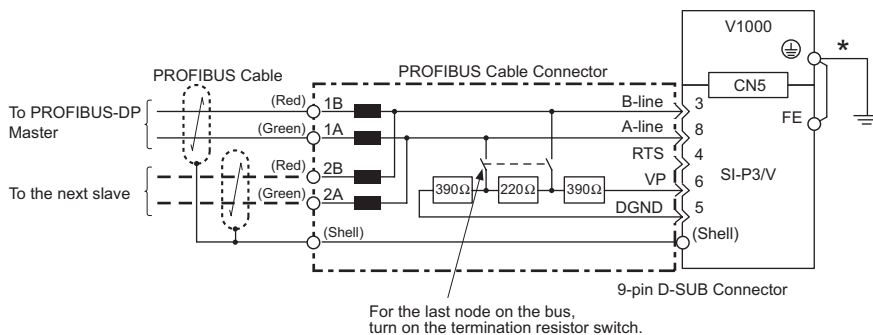

**Figure 4 Wiring Diagram**

\* The FE terminal on the PROFIBUS-DP Option is fitted with a ground cable that should be connected to the ground terminal on the drive.

### ■ PROFIBUS-DP Termination

The PROFIBUS-DP Option PCB is not supplied with a built-in network terminating resistor. Therefore, a 9-pin D-SUB connector with a built-in terminating resistor should be used. Ensure that the terminating resistors are only closed at the two segment ends and nowhere else. Any additional terminations can cause corruption of the PROFIBUS signals and network malfunction.

In PROFIBUS 9-pin D-SUB connectors, the switch for the bus termination often has the second function of isolating the outgoing cable from the connector to the next slave. It is essential that only the incoming cable entry is used on connectors located at the ends of the PROFIBUS segment. If an incorrect cable entry method is used, neither the PROFIBUS device nor the termination network will be connected to the network segment. Most connectors mark incoming and outgoing cable entries with arrows.

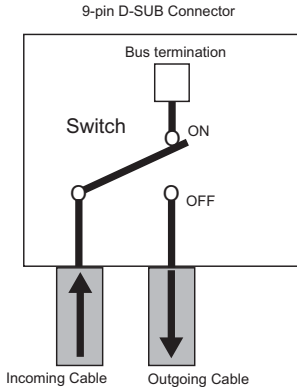

**Figure 5 PROFIBUS Cable Connection with Termination Resistors**

**Bus termination ON** = incoming and outgoing cables not connected.

**Bus termination OFF** = incoming and outgoing cables connected.

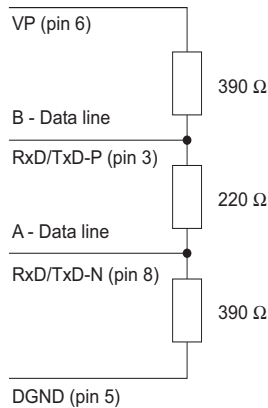

**Figure 6 Cable Termination of the PROFIBUS cable according to EN50170 (pin numbers for a 9-pin D-SUB connector)**

## 5 Installation Procedure

### ◆ Installing the Option Unit

Remove the front cover of the drive before installing the PROFIBUS-DP Option. Follow the directions below for proper installation.

1. Switch off the power supply to the drive.

**DANGER! Electrical Shock Hazard** - Do not connect or disconnect wiring while the power is on. Failure to comply will result in death or serious injury. Before installing the PROFIBUS-DP Option, disconnect all power to the drive. The internal capacitor remains charged even after the power supply is turned off. The charge indicator LED will extinguish when the DC bus voltage is below 50 Vdc. To prevent electric shock, wait at least five minutes after all indicators are off and measure the DC bus voltage level to confirm safe level.

2. Remove the front cover. The original drive front cover may be discarded because it will be replaced by the PROFIBUS-DP Option cover in step 7.

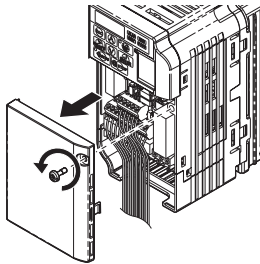

Figure 7 Remove Front Cover

3. Remove the bottom cover and connect the PROFIBUS-DP Option ground cable to the ground terminal.

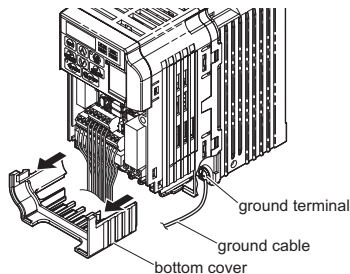
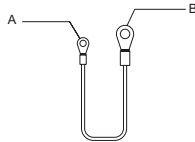

Figure 8 Connect Ground Cable

**Note:** The four different ground cables packaged with the PROFIBUS-DP Option connect the unit to different models. Select the proper ground cable from the PROFIBUS-DP Option kit depending on drive size.



- A – Option unit connection: screw size = M3**  
**B – Drive-side connection: screw size = M3.5 to M6**

**Figure 9 Ground Cable**

**Note: Cover removal for certain larger models with a Terminal Cover:**

- Single-Phase 200 V Class: CIMR-V□BA0006 to BA0020
- Three-Phase 200 V Class: CIMR-V□2A0008 to 2A0069
- Three-Phase 400 V Class: All models

Remove the terminal cover before removing the bottom cover to install the PROFIBUS-DP Option. Replace the terminal cover after wiring the PROFIBUS-DP Option.

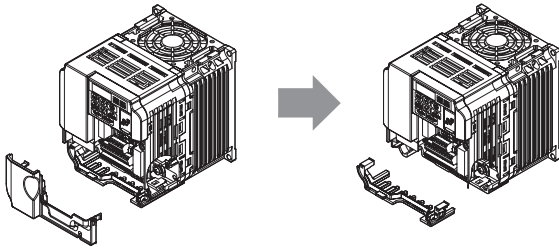

**Figure 10 Models with Terminal Cover**

4. Reattach the bottom cover.
5. Connect the PROFIBUS-DP Option to the drive. Properly secure the tabs on the left and right sides of the PROFIBUS-DP Option to the drive case.

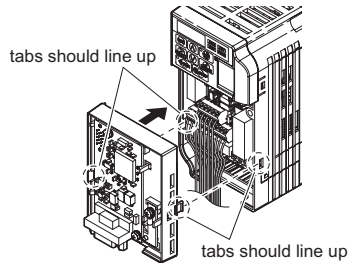

**Figure 11 Attach PROFIBUS-DP Option**

## 5 Installation Procedure

6. Connect the ground cable from the drive ground terminal to the PROFIBUS-DP Option ground. When wiring the PROFIBUS-DP Option, pass the ground cable through the inside of the drive bottom cover, then pass the ground cable into the through-hole at the front of the PROFIBUS-DP Option.

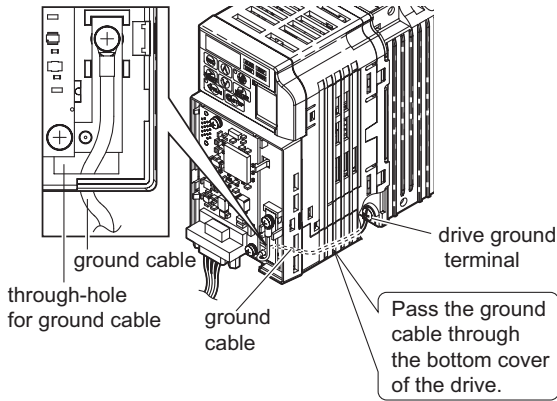

**Figure 12 Ground Cable Connection**

7. Attach the PROFIBUS-DP Option cover to the front of the PROFIBUS-DP Option.

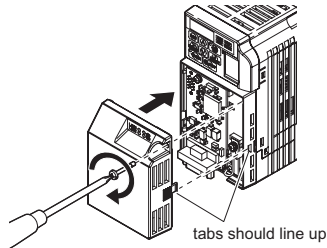

**Figure 13 Attach Cover**

**Note:** When using the drive in an area that may require displaying warning information in Japanese or Chinese, a sticker has been provided with the PROFIBUS-DP Option. This sticker can be placed over the English and French warnings on the front of the PROFIBUS-DP Option.

### ◆ Communication Cable Specifications

Use only PROFIBUS-DP dedicated communication cable; the Yaskawa warranty does not cover other cable types. For more information on cables, refer to the PROFIBUS-DP website at <http://www.profibus.com/>.

Yaskawa recommends using PROFIBUS cables suitable for the conditions listed in [Table 5](#).

#### ■ Cable Requirements

**Table 5 Communication Cable Requirements**

	Specifications
<b>Impedance</b>	135 to 165 $\Omega$ at a frequency of (3 to 20 MHz)
<b>Capacity</b>	30 pF/m maximum
<b>Loop resistance</b>	110 $\Omega$ /km maximum
<b>Core cross-section</b>	0.34 mm <sup>2</sup> minimum
<b>Core diameter</b>	0.64 mm minimum

#### ■ Cable Length

Communication speed determines maximum permissible cable length. [Table 6](#) shows the specifications for Type A bus cables.

**Table 6 Cable Length**

Communication speed (kbps)	Distance per segment (m)	Communication speed (kbps)	Distance per segment (m)
9.6	1200	500	400
19.2	1200	1500	200
45.45	1200	3000	100
93.75	1200	6000	100
187.5	1000	12000	100

### ◆ GSD Files

A GSD file is needed to use the SI-P3/V unit as a PROFIBUS-DP slave. Use the GSD file to register the SI-P3/V unit as a slave to a PROFIBUS-DP master.

To obtain the GSD file access:

U.S.: <http://www.yaskawa.com>

Europe: <http://www.yaskawa.eu.com>

Japan: <https://www.e-mechatronics.com>

Other areas: contact a Yaskawa representative

# 6 PROFIBUS-DP Option Drive Parameters

Confirm proper setting of the all parameters in *Table 7* before starting network communications.

**Table 7 Parameter Settings**

No.	Name	Description	Default
b1-01	Frequency Reference Selection *1	Selects the frequency reference input source 0: Operator - Digital preset speed d1-01 to d1-17 1: Terminals - Analog input terminal A1 or A2 2: MEMOBUS communications 3: Option PCB 4: Pulse Input (Terminal RP)	1
b1-02	Run Command Selection *1	Selects the run command input source 0: Digital Operator - RUN and STOP keys 1: Digital input terminals S1 to S7 2: MEMOBUS communications 3: Option PCB	1
F6-01	Operation Selection after Communications Error	Determines drive response when a bUS error is detected during communications with the PROFIBUS-DP Option 0: Ramp to Stop 1: Coast to Stop 2: Fast-Stop 3: Alarm Only	1
F6-02	External Fault Detection Conditions (EF0)	Sets the condition for external fault detection (EF0) 0: Always detected 1: Detected only during operation	0
F6-03	Stopping Method for External Fault from Communication Option Board	Determines drive response for external fault input (EF0) detection during PROFIBUS communication 0: Ramp to Stop 1: Coast to Stop 2: Fast-Stop 3: Alarm Only *2	1
F6-04	bUS Error Detection Delay Time	Set the maximum time the drive should wait for a communication error to occur (bUS) Range 0.00 to 5.00 s	0.05 s
F6-30	Node Address *3	0 to 125	0
F6-31	Clear Mode Selection	Selects the action to take when a "Clear Mode" command is received 0: Resets back to 0 1: Maintains the previous value	0
F6-32	PROFIBUS Map Selection	0: PPO Type 1: Conventional	0

- \* 1. To start and stop the drive with the PROFIBUS-DP master device using serial communications, set b1-02 to "3". To control the frequency reference of the drive via the master device, set b1-01 to "3".
- \* 2. If F6-03 is set to 3, then the drive will continue to operate when an EF0 fault is detected. Take proper safety measures, such as installing an emergency stop switch.
- \* 3. All node addresses must be unique. The ERR light will illuminate when 0 or greater than 125 is entered.

## 7 PROFIBUS-DP Option Data and I/O Maps

### ◆ Conventional Formats

The configuration tool of PROFIBUS-DP master sets the input and output data length of SI-P3/V from Extended Data 1 (32 bytes), Extended Data 2 (12 bytes), and Basic Data (6 bytes).

Conventional formats have two message types: High-speed I/O Data and MEMOBUS/Modbus message.

Set parameter F6-32 = “1” to use conventional formats.

#### ■ High-speed I/O data

High-speed I/O data is directly transferred to or from the drive and can control the drive.

#### ■ MEMOBUS/Modbus message

MEMOBUS/Modbus message data is transferred to the drive using MEMOBUS/Modbus messages. All the drive parameters and data can be accessed by this data. Because the data in this message type is transferred to the drive after the SI-P3/V receives and edits it, more time is required to return the data to the master. The master must synchronize the timing of sending and receiving the data by handshaking.

The drive run command and/or the frequency reference change immediately by High-speed I/O when commanded by MEMOBUS/Modbus messages.

#### ■ Memory Maps

The following memory maps show the I/O data bytes.

#### ■ Basic and Extended Register Maps

	Basic Data (6 bytes)	Extended Data 1 (32 bytes)	Extended Data 2 (12 bytes)
High-speed I/O Data	Bytes 0 to 5	Bytes 0 to 15	Bytes 0 to 3
MEMOBUS/Modbus Data	-	Bytes 16 to 31	Bytes 4 to 11

Table 8 Basic Data Register Map Detail

Output		Input	
Byte	Description	Byte	Description
0	Operation Command High Byte	0	Drive Status High Byte
1	Operation Command Low Byte	1	Drive Status Low Byte
2	Frequency Reference High Byte	2	Motor Speed High Byte <I>
3	Frequency Reference Low Byte	3	Motor Speed Low Byte <I>



## 7 PROFIBUS-DP Option Data and I/O Maps

Output		Input	
Byte	Description	Byte	Description
4	Not Used	4	Output Current High Byte <2>
5		5	Output Current High Byte <2>

<1> Unit depends on the setting of o1-03 (Digital Operator Display Scaling). The register content is zero if the drive is set for V/f control.

<2> 1 is 0.1 A for drives with a capacity of more than 11 kW.

**Table 9** and **Table 10** specify the data transferred in the Extended I/O data exchange message.

**Table 9 Extended Data 1 Register Map**

Output		Input	
Byte	Description	Byte	Description
0	Operation Command High Byte	0	Drive Status High Byte
1	Operation Command Low Byte	1	Drive Status Low Byte
2	Frequency Reference High Byte	2	Motor Speed High Byte <3>
3	Frequency Reference Low Byte	3	Motor Speed Low Byte <3>
4	Not Used	4	Torque Reference Monitor High Byte <4>
5		5	Torque Reference Monitor Low Byte <4>
6		6	Not Used
7		7	
8		8	Frequency Reference High Byte
9		9	Frequency Reference Low Byte
10	Analog Output Channel 1 High Byte <4>	10	Output Frequency High Byte
11	Analog Output Channel 1 Low Byte <4>	11	Output Frequency Low Byte
12	Not Used	12	Output Current High Byte <5>
13		13	Output Current Low Byte <5>
14	Digital Output High Byte <2>	14	Analog Input Channel 1 High Byte
15	Digital Output Low Byte <2>	15	Analog Input Channel 1 Low Byte
16	MEMOBUS/Modbus Function Code	16	MEMOBUS/Modbus Function Code
17	MEMOBUS/Modbus Starting Register Address High Byte	17	MEMOBUS/Modbus Starting Register Address High Byte
18	MEMOBUS/Modbus Starting Register Address Low Byte	18	MEMOBUS/Modbus Starting Register Address Low Byte
19	MEMOBUS/Modbus Number of Data	19	MEMOBUS/Modbus Number of Data
20	MEMOBUS/Modbus Data 1 High Byte	20	MEMOBUS/Modbus Data 1 High Byte
21	MEMOBUS/Modbus Data 1 Low Byte	21	MEMOBUS/Modbus Data 1 Low Byte
22	MEMOBUS/Modbus Data 2 High Byte	22	MEMOBUS/Modbus Data 2 High Byte
23	MEMOBUS/Modbus Data 2 Low Byte	23	MEMOBUS/Modbus Data 2 Low Byte
24	MEMOBUS/Modbus Data 3 High Byte	24	MEMOBUS/Modbus Data 3 High Byte
25	MEMOBUS/Modbus Data 3 Low Byte	25	MEMOBUS/Modbus Data 3 Low Byte

## 7 PROFIBUS-DP Option Data and I/O Maps

Output		Input	
Byte	Description	Byte	Description
26	MEMOBUS/Modbus Data 4 High Byte	26	MEMOBUS/Modbus Data 4 High Byte
27	MEMOBUS/Modbus Data 4 Low Byte	27	MEMOBUS/Modbus Data 4 Low Byte
28	Not Used	28	Not Used
29			
30			
31	Hand Shake Register	31	Hand Shake Register

- <1> To select drive analog output channel for communications, set H4-01 (Multi-Function Analog Output Terminal AM) to 31 (Not used)
- <2> Drive digital output ON/OFF during communications, set H2-01 (Terminal MA, MB and MC Function Selection (relay)), H2-02 (Terminal P1 Function Selection (open-collector)), and H2-03 (Terminal P2 Function Selection (open-collector)) to F.
- <3> Unit depends on the setting of o1-03 (Digital Operator Display Scaling). The register content is zero if the drive is set for V/f control.
- <4> Cannot be used when setting A1-02 (Control Method Selection) to 0 (V/f Control without PG).
- <5> 1 is 0.1 A for drives with a capacity of more than 11 kW.

The register exchanged in input byte 2, 3 in [Table 10](#) depends on the control method specified in parameter U1-04. If U1-04 = 0 or 5 (V/f mode or PM V/f mode), the output frequency register is changed.

**Table 10 Extended Data 2 Register Map**

Output		Input	
Byte	Description	Byte	Description
0	Operation Command High Byte	0	Drive Status High Byte
1	Operation Command Low Byte	1	Drive Status Low Byte
2	Frequency Reference High Byte	2	Motor Speed High Byte </>
3	Frequency Reference Low Byte	3	Motor Speed Low Byte </>
4	MEMOBUS/Modbus Function Code	4	MEMOBUS/Modbus Function Code
5	MEMOBUS/Modbus Starting Register Address High Byte	5	MEMOBUS/Modbus Starting Register Address High Byte
6	MEMOBUS/Modbus Starting Register Address Low Byte	6	MEMOBUS/Modbus Starting Register Address Low Byte
7	MEMOBUS/Modbus Data Length	7	MEMOBUS/Modbus Data Length
8	MEMOBUS/Modbus Data 1 High Byte	8	MEMOBUS/Modbus Data 1 High Byte
9	MEMOBUS/Modbus Data 1 Low Byte	9	MEMOBUS/Modbus Data 1 Low Byte
10	Not Used	10	Not Used
11	Hand Shake Register	11	Hand Shake Register

- <1> Unit depends on the setting of o1-03 (Digital Operator Display Scaling). The register content is zero if the drive is set for V/f control.

## 7 PROFIBUS-DP Option Data and I/O Maps

### ◆ Parameter Process Data Object (PPO) Type Formats

Set drive parameter F6-32 = "0" to use PPO type formats. The PPO is defined for cyclic data transfer, which allows the master and the slave to exchange process data (PZD) and parameters. Refer to the PROFIBUS specification for more information on PPO types 1~5.

SI-P3/V supports five possible PPO type formats:

PPO type 1 (4 words PKW + 2 words PZD)
PPO type 2 (4 words PKW + 6 words PZD)
PPO type 3 (2 words PZD)
PPO type 4 (6 words PZD)
PPO type 5 (4 words PKW + 10 words PZD)

All PPO Types have the registers STW, ZSW, HSW, and HIW. These registers are not mapped directly to drive registers. The contents of the words are defined in the Register Maps, referred to as "Register Ptr".

PKW			PZD									
PKE	IND	PWE	PZD1 STW ZSW	PZD2 HSW HIW	PZD3	PZD4	PZD5	PZD6	PZD7	PZD8	PZD9	PZD10
PPO TYPE 1: Octet-String 12												
PPO TYPE 2: Octet-String 20												
PPO TYPE 3: Octet-String 4												
PPO TYPE 4: Octet-String 12												
PPO TYPE 5: Octet-String 28												

PKW: Parameter ID/value

PZD: Process Data, cyclically transferred

PKE: Parameter ID (1st and 2nd octet)

IND: Sub-index (3rd octet), 4th octet is reserved

PWE: Parameter value (5th until 8th octet)

STW: Control word

HSW: Main setpoint

ZSW: Status word

HIW: Main actual value

## 8 Troubleshooting

### ◆ Drive-Side Error Codes

Drive-side error codes appear on the drive's LED operator. Causes of the errors and corrective actions are listed in [Table 11](#).

For additional error codes that may appear on the LED operator screen, refer to the instruction manual for the drive.

### ■ Faults

Both bUS (PROFIBUS-DP Option Communication Error) and EF0 (External Fault Input from the PROFIBUS-DP Option) can appear as an alarm or as a fault. When a fault occurs, the digital operator LEDs remain lit. When an alarm occurs, the digital operator LEDs flash and the ALM light turns on.

If communication stops while the drive is running, answer the following questions to help remedy the fault:

- Is the PROFIBUS-DP Option properly installed?
- Is the communication line properly connected to the PROFIBUS-DP Option? Is it loose?
- Is the controller program working? Has the controller CPU stopped?
- Did a momentary power loss interrupt communications?

## 8 Troubleshooting

**Table 11 Fault Display and Possible Solutions**

LED Operator Display		Fault Name
<i>bUS</i>	bUS	PROFIBUS-DP Option Communication Error
		After establishing initial communication, the connection was lost. Only detected when the run command frequency reference is assigned to the option.
Cause		Possible Solution
Master controller (PLC) has stopped communicating.		Check for faulty wiring. ⇒ Correct any wiring problems.
Communication cable is not connected properly.		
A data error occurred due to noise.		Check the various options available to minimize the effects of noise. ⇒ Take steps to counteract noise in the control circuit wiring, main circuit lines, and ground wiring. ⇒ If a magnetic contactor is identified as a source of noise, install a surge absorber to the contactor coil. ⇒ Use cables recommended by Yaskawa, or another type of shielded line. The shield should be grounded on the controller side and on the PROFIBUS-DP Option side.
PROFIBUS-DP Option is damaged.		⇒ If there are no problems with the wiring and the error continues to occur, replace the PROFIBUS-DP Option.
PROFIBUS-DP Option is not properly connected to the drive.		The connector pins on the PROFIBUS-DP Option are not properly seated with the connector pins on the drive. ⇒ Reinstall the PROFIBUS-DP Option

LED Operator Display		Fault Name
<i>EF0</i>	EF0	External Fault Input from PROFIBUS-DP Option
		The alarm function for an external device has been triggered.
Cause		Corrective Action
An external fault is being sent from the upper controller (PLC).		⇒ Remove the cause of the external fault. ⇒ Reset the external fault input from the upper controller (PLC) device.
Problem with the upper controller (PLC) program.		⇒ Check the program used by the upper controller (PLC) and make the appropriate corrections.

LED Operator Display		Fault Name
	oFA00	PROFIBUS-DP Option Fault (Port A)
		PROFIBUS-DP Option is not properly connected.
Cause		Corrective Action
Non-compatible option connected to the drive.		⇒ Connect an option that is compatible with the drive.

LED Operator Display		Fault Name
	oFA01	PROFIBUS-DP Option Fault (Port A)
		PROFIBUS-DP Option is not properly connected.
Cause		Corrective Action
Problem with the connectors between the drive and PROFIBUS-DP Option.		⇒ Turn the power off and check the connectors between the drive and PROFIBUS-DP Option.

LED Operator Display		Fault Name
	oFA03	PROFIBUS-DP Option Fault (Port A)
		PROFIBUS-DP Option self-diagnostics error.
Cause		Corrective Action
PROFIBUS-DP Option hardware fault.		⇒ Replace the PROFIBUS-DP Option. Contact Yaskawa for assistance.

LED Operator Display		Fault Name
	oFA04	PROFIBUS-DP Option Fault (Port A)
		PROFIBUS-DP Option Flash write mode
Cause		Corrective Action
PROFIBUS-DP Option hardware fault.		⇒ Replace the PROFIBUS-DP Option. Contact Yaskawa for assistance.

# 9 Specifications

### ◆ Specifications

**Table 12 Option Unit Specifications**

Model	SI-P3/V (PCB model: SI-P3)
PROFIBUS-DP Data	PROFIBUS DP-V0, V1 PPO TYPE: 1~5 (No. 3.072, Profile for Variable Speed Drives) Extended data1 High-speed I/O data (inputs: 16 bytes, outputs: 16 bytes) MEMOBUS/Modbus message (inputs: 16 bytes, outputs: 16 bytes) Extended data2 High-speed I/O data (inputs: 4 bytes, outputs: 4 bytes) MEMOBUS/Modbus message (inputs: 8 bytes, outputs: 8 bytes) Basic data High-speed I/O data (inputs: 6 bytes, outputs: 6 bytes)
Connector	9 pin D-SUB connector (#4/40 UNC thread)
Communications Speed	9.6 kbps to 12 Mbps
Ambient Temperature	-10 °C to +50 °C
Humidity	up to 95% RH (no condensation)
Storage Temperature	-20 °C to +60 °C (allowed for short-term transport of the product)
Area of Use	Indoor (free of corrosive gas, airborne particles, etc.)
Altitude	up to 1000 m

---

## ◆ Revision History

The revision dates and the numbers of the revised manuals appear on the bottom of the back cover.

MANUAL NO. TOBP C730600 23A

© Printed in Japan May 2007 07-5  
└─ Date of printing ─┬─ Date of original publication

<b>Date of Printing</b>	<b>Revision Number</b>	<b>Section</b>	<b>Revised Content</b>
May 2007	–	–	First edition



YASKAWA AC Drive-V1000 Option

# PROFIBUS-DP Installation Manual

---

**IRUMA BUSINESS CENTER (SOLUTION CENTER)**

480, Kamifujiyawa, Iruma, Saitama 358-8555, Japan  
Phone 81-4-2962-5696 Fax 81-4-2962-6138

**YASKAWA ELECTRIC AMERICA, INC.**

2121 Norman Drive South, Waukegan, IL 60085, U.S.A.  
Phone 1-847-887-7000 Fax 1-847-887-7370

**YASKAWA ELÉTRICO DO BRASIL COMÉRCIO LTD.A.**

Avenida Fagundes Filho, 620 Bairro Saude-Sao Pãulo-SP, Brazil CEP: 04304-000  
Phone 55-11-5071-2552 Fax 55-11-5581-8795

**YASKAWA ELECTRIC EUROPE GmbH**

Am Kronberger Hang 2, 65824 Schwalbach, Germany  
Phone 49-6196-569-300 Fax 49-6196-569-312

**YASKAWA ELECTRIC UK LTD.**

1 Hunt Hill Orchardton Woods Cumbernauld, G68 9LF, United Kingdom  
Phone 44-1236-735000 Fax 44-1236-458182

**YASKAWA ELECTRIC KOREA CORPORATION**

7F, Doore Bldg. 24, Yeoido-dong, Youngdungpo-Ku, Seoul 150-877, Korea  
Phone 82-2-784-7844 Fax 82-2-784-8495

**YASKAWA ELECTRIC (SINGAPORE) PTE. LTD.**

151 Lorong Chuan, #04-01, New Tech Park 556741, Singapore  
Phone 65-6282-3003 Fax 65-6289-3003

**YASKAWA ELECTRIC (SHANGHAI) CO., LTD.**

No.18 Xizang Zhong Road. Room 1702-1707, Harbour Ring Plaza Shanghai 200001, China  
Phone 86-21-5385-2200 Fax 86-21-5385-3299

**YASKAWA ELECTRIC (SHANGHAI) CO., LTD. BEIJING OFFICE**

Room 1011A, Tower W3 Oriental Plaza, No.1 East Chang An Ave.,  
Dong Cheng District, Beijing 100738, China  
Phone 86-10-8518-4086 Fax 86-10-8518-4082

**YASKAWA ELECTRIC TAIWAN CORPORATION**

9F, 16, Nanking E. Rd., Sec. 3, Taipei, Taiwan  
Phone 886-2-2502-5003 Fax 886-2-2505-1280



YASKAWA

YASKAWA ELECTRIC CORPORATION

In the event that the end user of this product is to be the military and said product is to be employed in any weapons systems or the manufacture thereof, the export will fall under the relevant regulations as stipulated in the Foreign Exchange and Foreign Trade Regulations. Therefore, be sure to follow all procedures and submit all relevant documentation according to any and all rules, regulations and laws that may apply.

Specifications are subject to change without notice for ongoing product modifications and improvements.

© 2007 YASKAWA ELECTRIC CORPORATION. All rights reserved.

MANUAL NO. TOBP C730600 23A

Printed in Japan May 2007 07-5

07-4